



Sales Sample Order Form

(10/06/15)

Customer Account No. _____

Customer Purchase Order No. _____

Sold To: _____

Ship To: _____

Ship Via: Best Way – Prepay and Add

HSS-SK-MFQ	Premium KD / Maintenance Free Quiet	_____ @ \$100.00 each = \$ _____
HSS-HDC	HDC Premier / HDC	_____ @ \$100.00 each = \$ _____
HSS-HDV	Heavy-Duty Ventilated (HDV) KD	_____ @ \$100.00 each = \$ _____
HSS-Safety-View	Safety-View / Safety-View Plus KD	_____ @ \$100.00 each = \$ _____
HSS-HYBRID	Metal / Wood Hybrid KD	_____ @ \$100.00 each = \$ _____
HSS-H1001	Turn Handle Athletic / THA Elite	_____ @ \$100.00 each = \$ _____
HSS-H1002/6/3	Welded Unibody Athletic & Corridor	_____ @ \$100.00 each = \$ _____
HSS-H1004/5	Welded Single-Point Athletic & Corridor	_____ @ \$100.00 each = \$ _____
HSS-CUB	Primary II/Backpack Cubbie	_____ @ \$100.00 each = \$ _____
HSS-Recruiter	All-Wood Open-Front Sport	_____ @ \$100.00 each = \$ _____
HSS-Aquamax	HDPE Plastic Aquamax	_____ @ \$100.00 each = \$ _____

Total = \$ _____

Ordered By: _____

Date Ordered: _____

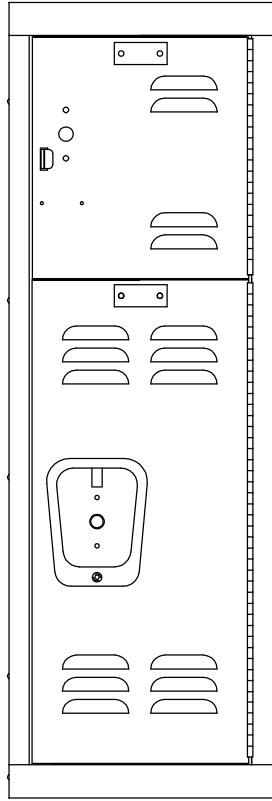

SIDE ONE

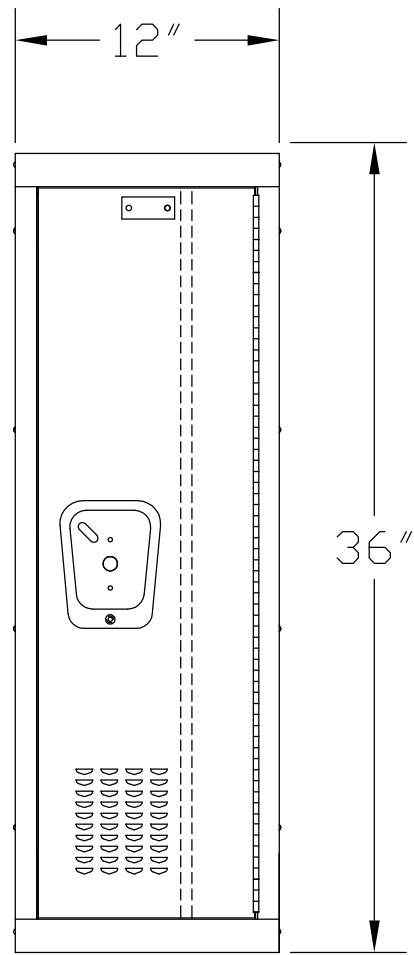

SIDE TWO

HALLOWELL SALES SAMPLE - STANDARD KD / MAINTENANCE FREE QUIET

COMPONENT	GAUGE	MATERIAL	REMARKS
SIDE ONE			
TOP DOOR	18	COLD ROLLED STEEL	3" LOUVERS
TOP DOOR HANDLE		ZINC PLATED C.R.S.	FRICTION CATCH FINGER PULL
TOP DOOR HINGE	16	COLD ROLLED STEEL	CONTINUOUS PIANO TYPE
BOTTOM DOOR	16	COLD ROLLED STEEL	3" LOUVERS
BOTTOM DOOR HANDLE		STAINLESS STEEL	LIFT (RECESSED DRAWN HANDLE)
BOTTOM DOOR HINGE	16	COLD ROLLED STEEL	CONTINUOUS PIANO TYPE
SIDE TWO			
DOOR	16	COLD ROLLED STEEL	PLAIN (TOP) / SECURITY PLUS (BOTTOM)
HANDLE		STAINLESS STEEL	SINGLE POINT (RECESSED DRAWN HANDLE)
HINGE	16	COLD ROLLED STEEL	CONTINUOUS PIANO TYPE
STIFFENER	18	COLD ROLLED STEEL	FULL HEIGHT
SIDES			
BOTTOM	24	COLD ROLLED STEEL	SOLID
HAT SHELF	24	COLD ROLLED STEEL	SOLID
TOP	16	COLD ROLLED STEEL	SOLID
FRAME	16	COLD ROLLED STEEL	SOLID



Description:

STD KD / MAINT. FREE QUIET
SALES SAMPLE

Drawn By:

JDF

Checked By:

Date:

11/12/07

Scale:

None

Acad Number:

HSS-SK-MFQ elevation

Sheet

Of

Revision: 2

Drawing Number:

HSS-SK-MFQ

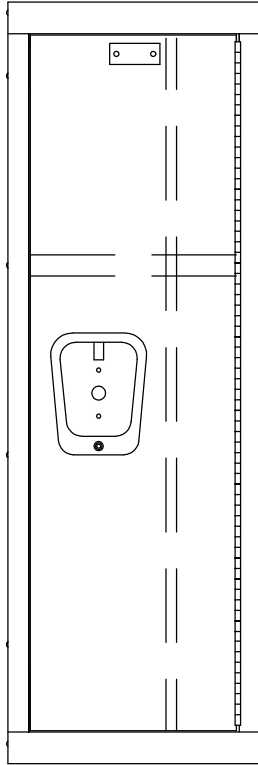

SIDE ONE

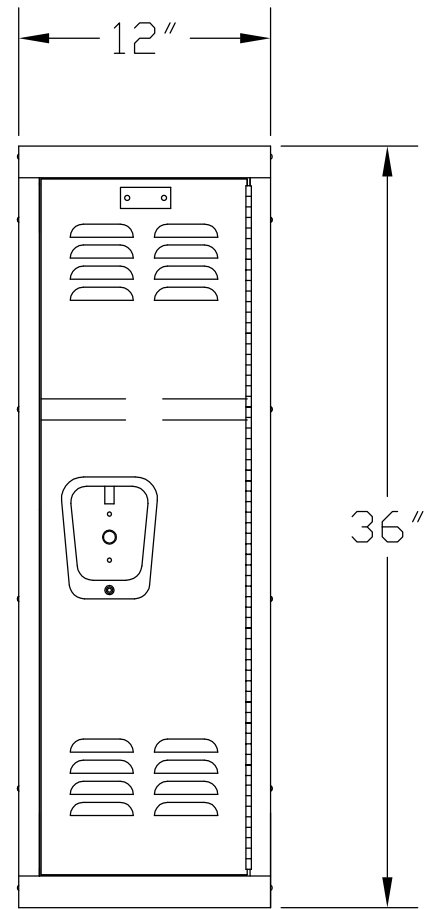

SIDE TWO

HALLOWELL SALES SAMPLE - HDC PREMIER / HDC

COMPONENT	GAUGE	MATERIAL	REMARKS
SIDE ONE			
DOOR	14	COLD ROLLED STEEL	PLAIN
HANDLE		STAINLESS STEEL	LIFT (RECESSED DRAWN HANDLE)
HINGE	16	COLD ROLLED STEEL	CONTINUOUS PIANO TYP
STIFFENER	18	COLD ROLLED STEEL	FULL HEIGHT
SIDE TWO			
DOOR	14	COLD ROLLED STEEL	3" LOUVERS
HANDLE		STAINLESS STEEL	LIFT (RECESSED DRAWN HANDLE)
HINGE	16	COLD ROLLED STEEL	CONTINUOUS PIANO TYP
SIDES	24	COLD ROLLED STEEL	SOLID
BOTTOM	24	COLD ROLLED STEEL	SOLID
HAT SHELF	24	COLD ROLLED STEEL	SOLID
TOP	16	COLD ROLLED STEEL	SOLID
FRAME	16	COLD ROLLED STEEL	SOLID



Description: HDC PREMIER /HDC SALES SAMPLE			
Drawn By: JDF	Checked By:	Date: 08/24/07	Scale: NONE
Acad Number: HSS-HDC- ELEVATION		Sheet 0f	Revision: 1
Drawing Number:		HSS-HDC	

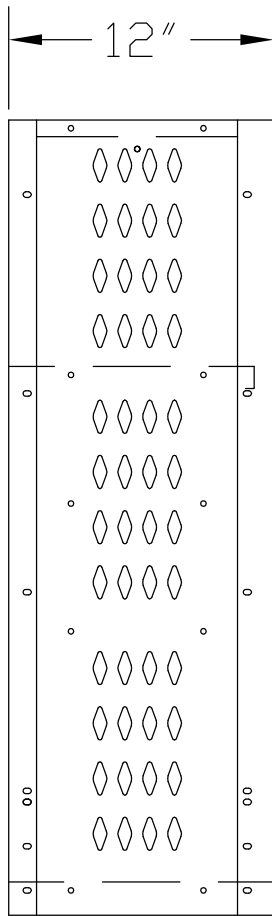

SIDE VIEW

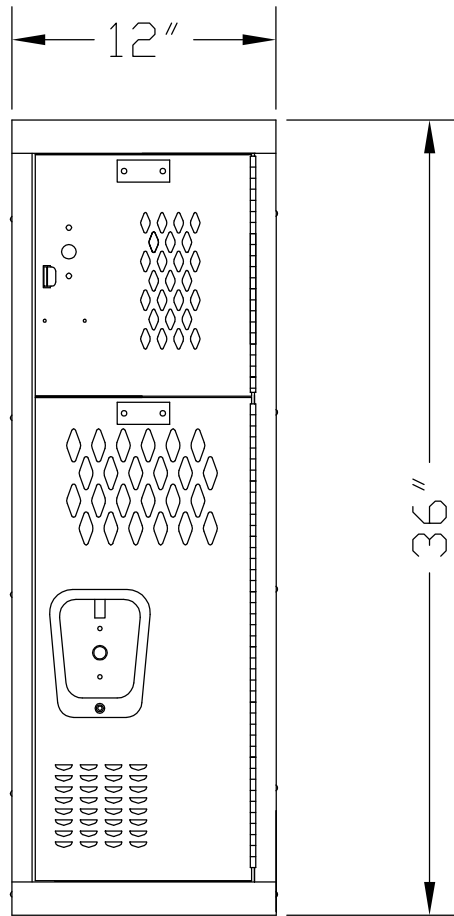

FRONT VIEW

<i>HALLOWELL SALES SAMPLE - HEAVY DUTY VENTILATED</i>			
COMPONENT	GAUGE	MATERIAL	REMARKS
TOP DOOR	14	COLD ROLLED STEEL	DIAMOND PERFORATED
TOP DOOR HANDLE		ZINC PLATED C.R.S.	FRICTION CATCH FINGER PULL
TOP DOOR HINGE	16	COLD ROLLED STEEL	CONTINUOUS PIANO TYPE
BOTTOM DOOR	14	COLD ROLLED STEEL	DIAM. PERF. (TOP) / SECURITY PLUS (BOTTOM)
BOTTOM DOOR HANDLE		STAINLESS STEEL	LIFT (RECESSED DRAWN HANDLE)
BOTTOM DOOR HINGE	16	COLD ROLLED STEEL	CONTINUOUS PIANO TYPE
SIDES	16	COLD ROLLED STEEL	DIAMOND PERFORATED
BACK	18	COLD ROLLED STEEL	SOLID
BOTTOM	16	COLD ROLLED STEEL	SOLID
HAT SHELF	16	COLD ROLLED STEEL	SOLID
TOP	16	COLD ROLLED STEEL	SOLID
FRAME	16	COLD ROLLED STEEL	SOLID

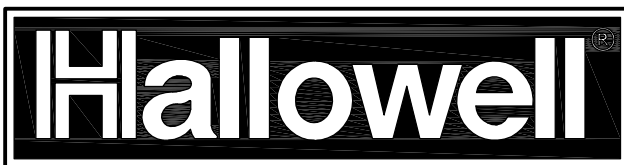

Description:

HEAVY DUTY VENTILATED
SALES SAMPLE

Drawn By:

JDF

Checked By:

Date:

08/24/07

Scale:

None

Acad Number:

HSS-HDV- elevation

Sheet

Of

Revision: 1

Drawing Number:

HSS-HDV

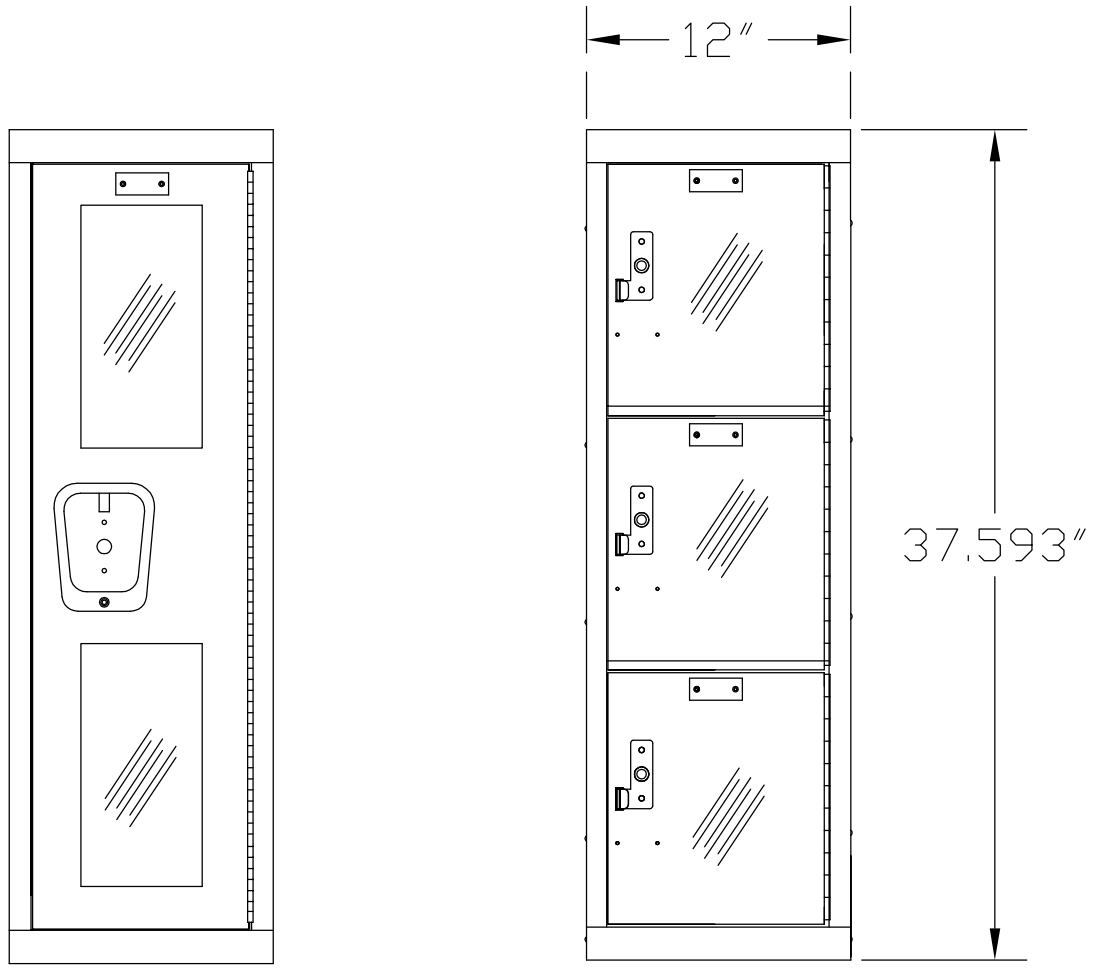

SIDE ONE

SIDE TWO

<i>HALLOWELL SALES SAMPLE - SAFETY VIEW</i>			
COMPONENT	GAUGE	MATERIAL	REMARKS
SIDE ONE			
DOOR	18	COLD ROLLED STEEL	PLAIN W/SAFTEY VIEW WINDOW
HANDLE		STAINLESS STEEL	LIFT (RECESSED DRAWN HANDLE)
HINGE	16	COLD ROLLED STEEL	CONTINUOUS PIANO TYPE
SIDE TWO			
DOORS		POLYCARBONATE	CLEAR
HANDLE		ZINC PLATED C.R.S.	FRICTION CATCH DOOR PULL
HINGE	16	COLD ROLLED STEEL	CONTINUOUS PIANO TYPE
SIDES	24	COLD ROLLED STEEL	SOLID
BOTTOM	24	COLD ROLLED STEEL	SOLID
HAT SHELF	24	COLD ROLLED STEEL	SOLID
TOP	16	COLD ROLLED STEEL	SOLID
FRAME	16	COLD ROLLED STEEL	SOLID



Description:

SAFETY VIEW
SALES SAMPLE

Drawn By: JDF

Checked By:

Date: 11/12/07

Scale: None

Acad Number: HSS-SAFETY VIEW- elevation

Sheet Of

Revision: 2

Drawing Number:

HSS-SAFETY VIEW

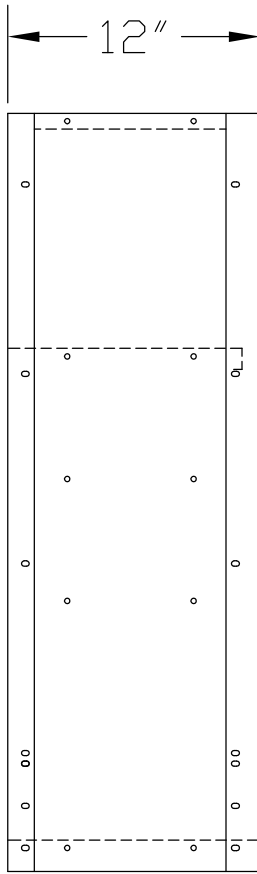

SIDE VIEW

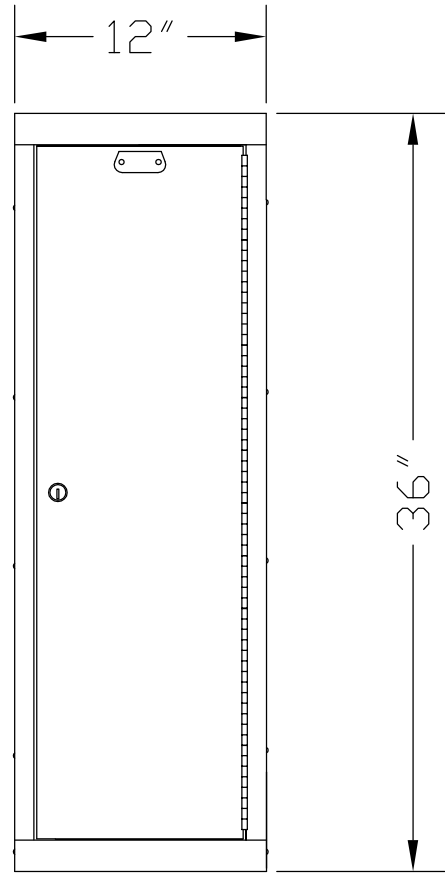

FRONT VIEW

<i>AMP SALES SAMPLE - HEAVY DUTY VENTILATED</i>			
COMPONENT	GAUGE	MATERIAL	REMARKS
DOOR		3/4" FURNITURE GRADE RED OAK PLYWOOD	
DOOR HANDLE			KEYED CAM LOCK
DOOR HINGE	16	COLD ROLLED STEEL	CONTINUOUS PIANO TYPE
SIDES	24	COLD ROLLED STEEL	SOLID
BACK	24	COLD ROLLED STEEL	SOLID
BOTTOM	24	COLD ROLLED STEEL	SOLID
HAT SHELF	24	COLD ROLLED STEEL	SOLID
TOP	16	COLD ROLLED STEEL	SOLID
FRAME	16	COLD ROLLED STEEL	SOLID

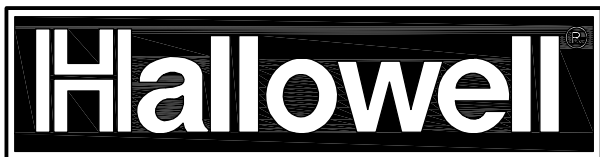

Description: HYBRID SALES SAMPLE			
Drawn By: JFA	Checked By:	Date: 09/26/11	Scale: NONE
Acad Number: HSS-HYBRID-ELEVATION		Sheet 0f	Revision: 1
Drawing Number:		HSS-HYBRID	

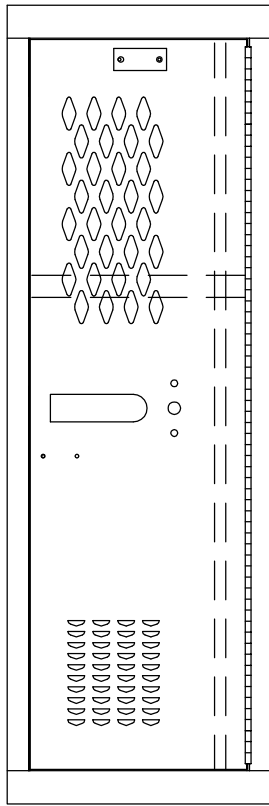

SIDE ONE

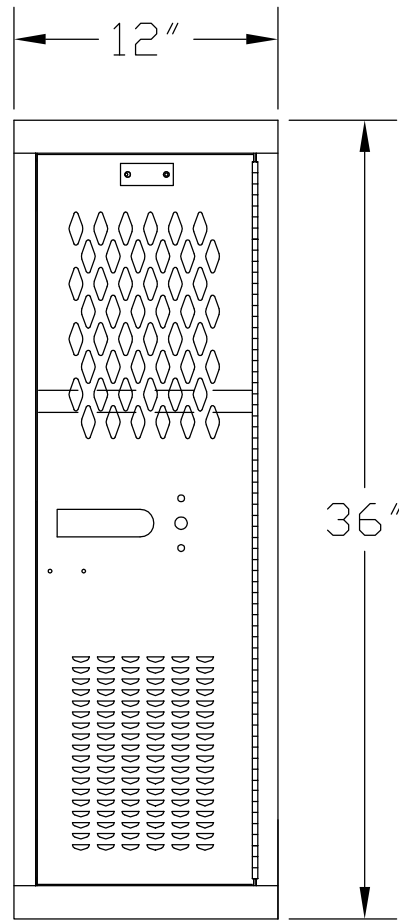

SIDE TWO

<i>HALLOWELL SALES SAMPLE - WELDED TURN-HANDLE ATHLETIC</i>			
COMPONENT	GAUGE	MATERIAL	REMARKS
SIDE ONE			
DOOR	14	COLD ROLLED STEEL	DIAM PERF (TOP) / SECURITY PLUS (BOTTOM)
HANDLE		COLD ROLLED STEEL	TURN HANDLE
HINGES	16	COLD ROLLED STEEL	CONTINUOUS PIANO TYPE
STIFFENER	18	COLD ROLLED STEEL	FULL HEIGHT
SIDE TWO			
DOOR	14	COLD ROLLED STEEL	DIAM PERF (TOP) / SECURITY PLUS (BOTTOM)
HANDLE		COLD ROLLED STEEL	TURN HANDLE
HINGE	16	COLD ROLLED STEEL	CONTINUOUS PIANO TYPE
SIDES	16	COLD ROLLED STEEL	DIAMOND PERFORATED
BOTTOM	16	COLD ROLLED STEEL	SOLID
HAT SHELF	16	COLD ROLLED STEEL	SOLID
TOP	16	COLD ROLLED STEEL	SOLID
FRAME	16	COLD ROLLED STEEL	SOLID

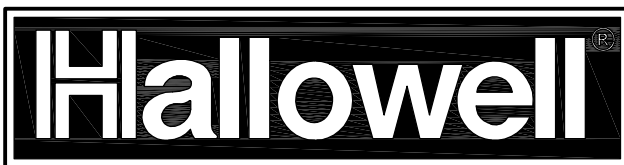

Description:

WELDED TURN-HANDLE ATHLETIC
SALES SAMPLE

Drawn By:

JDF

Checked By:

Date:

08/24/07

Scale:

None

Acad Number:

HSS-1001-elevation

Sheet

Of

Revision: 1

Drawing Number:

HSS-H1001

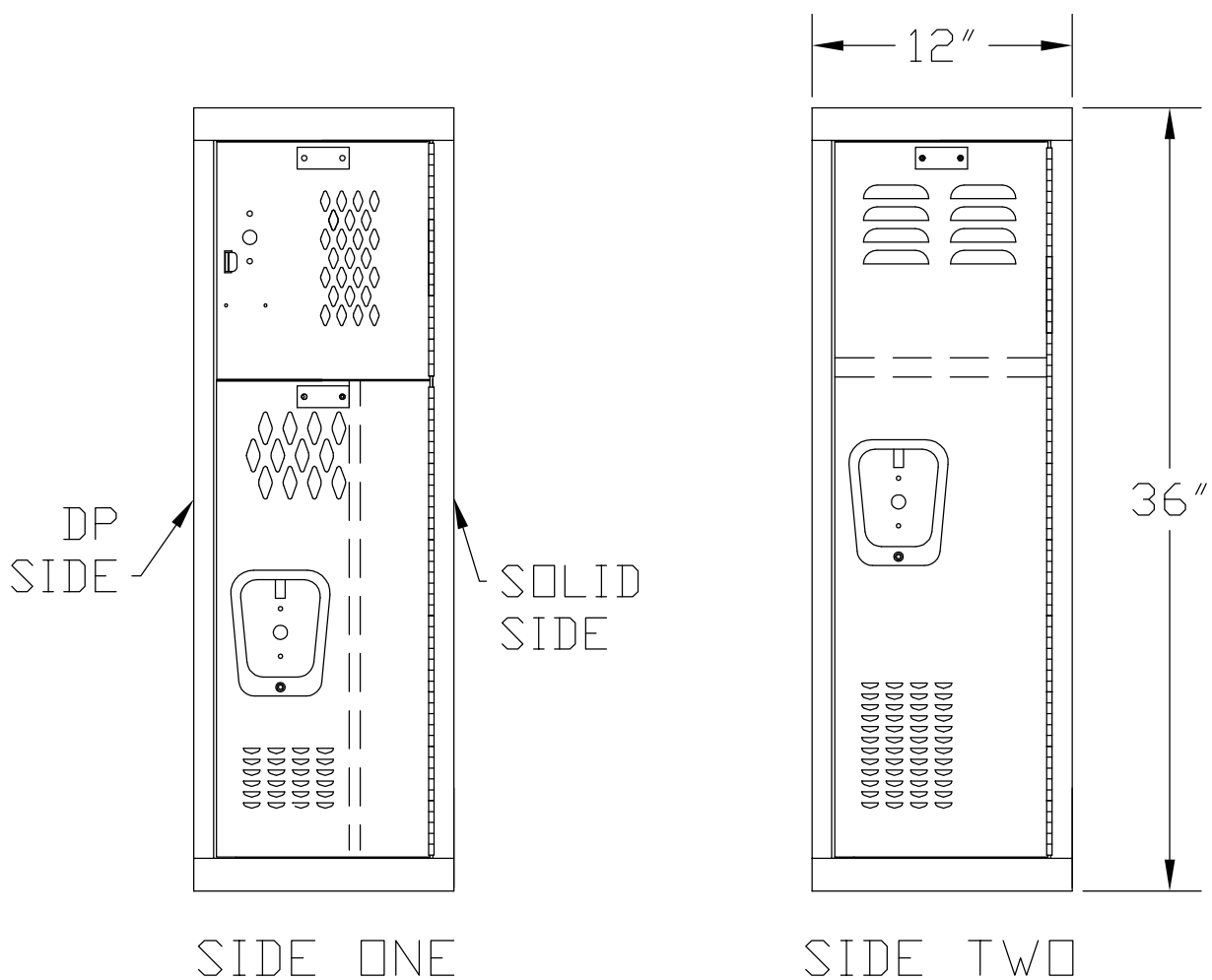

SIDE ONE

SIDE TWO

HALLOWELL SALES SAMPLE - WELDED ATHLETIC AND CORRIDOR			
COMPONENT	GAUGE	MATERIAL	REMARKS
SIDE ONE			
TOP DOOR	14	COLD ROLLED STEEL	DIAMOND PERFORATED (SIDE HINGED)
TOP DOOR HANDLE		ZINC PLATED C.R.S.	FRICTION CATCH DOOR PULL
TOP DOOR HINGE	16	COLD ROLLED STEEL	CONTINUOUS PIANO TYPE
STIFFENER	18	COLD ROLLED STEEL	FULL HEIGHT (24" HIGH DOOR ONLY)
BOTTOM DOOR	14	COLD ROLLED STEEL	DIAM PERF (TOP) / SECURITY PLUS (BOTTOM)
BOTTOM DOOR HANDLE		STAINLESS STEEL	LIFT (RECESSED DRAWN HANDLE)
BOTTOM DOOR HINGE	16	COLD ROLLED STEEL	CONTINUOUS PIANO TYPE
STIFFENER	18	COLD ROLLED STEEL	FULL HEIGHT
SIDE TWO			
DOOR	14	COLD ROLLED STEEL	LOUVERED (TOP) / SECURITY PLUS (BOTTOM)
DOOR HANDLE		STAINLESS STEEL	LIFT (RECESSED DRAWN HANDLE)
DOOR HINGE	16	COLD ROLLED STEEL	CONTINUOUS PIANO TYPE
SOLID SIDE			
DP SIDE	16	COLD ROLLED STEEL	DIAMOND PERFORATED
BOTTOM	16	COLD ROLLED STEEL	SOLID
HAT SHELF	16	COLD ROLLED STEEL	SOLID
TOP	16	COLD ROLLED STEEL	SOLID
FRAME	16	COLD ROLLED STEEL	SOLID

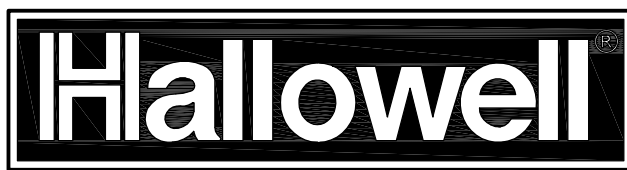

Description: WELDED UNIBODY ATHLETIC & CORRIDOR SALES SAMPLE

Drawn By: JDF Checked By: Date: 11/12/07 Scale: None

Acad Number: HSS-1002/1006/1003 elevation Sheet Of Revision: 3

Drawing Number: HSS-1002/6/3

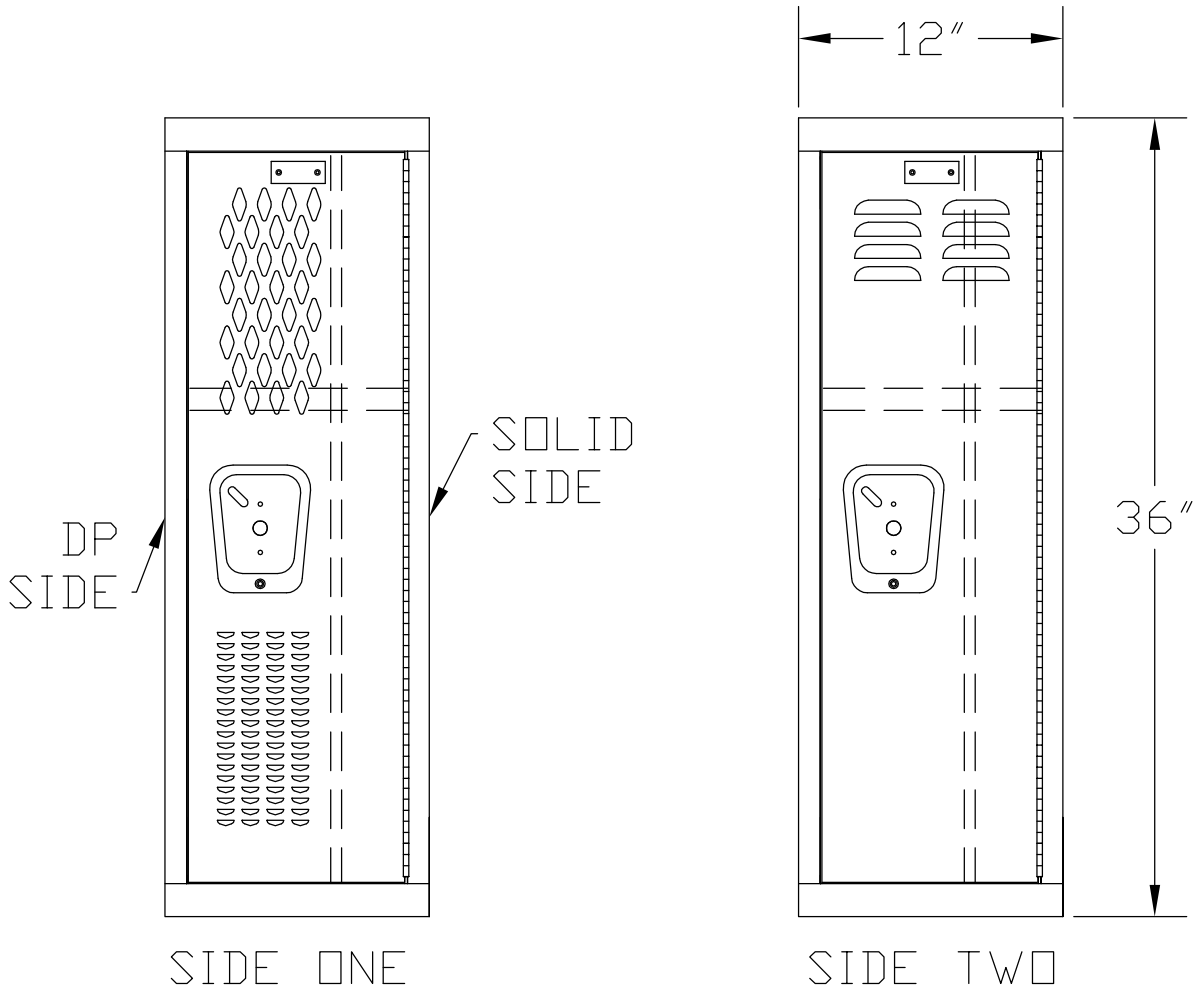

HALLOELL SALES SAMPLE - WELDED SINGLE-POINT ATHLETIC & CORRIDOR

COMPONENT	GAUGE	MATERIAL	REMARKS
SIDE ONE			
DOOR	14	COLD ROLLED STEEL	DIAM. PERF. (TOP) / SECURITY PLUS (BOTTOM)
HANDLE		STAINLESS STEEL	SINGLE POINT (RECESSED DRAWN HANDLE)
HINGE	16	COLD ROLLED STEEL	CONTINUOUS PIANO TYPE
STIFFENER	18	COLD ROLLED STEEL	FULL HEIGHT
SIDE TWO			
DOOR	14	COLD ROLLED STEEL	LOUVERED (TOP) / PLAIN (BOTTOM)
HANDLE		STAINLESS STEEL	SINGLE POINT (RECESSED DRAWN HANDLE)
HINGE	16	COLD ROLLED STEEL	CONTINUOUS PIANO TYPE
STIFFENER	18	COLD ROLLED STEEL	FULL HEIGHT
SIDE	16	COLD ROLLED STEEL	DIAMOND PERFORATED
SIDE	16	COLD ROLLED STEEL	SOLID
BACK	18	COLD ROLLED STEEL	SOLID
BOTTOM	16	COLD ROLLED STEEL	SOLID
HAT SHELF	16	COLD ROLLED STEEL	SOLID
TOP	16	COLD ROLLED STEEL	SOLID
FRAME	16	COLD ROLLED STEEL	SOLID



Description:

WELDED SINGLE-POINT ATHLETIC & CORRIDOR
SALES SAMPLE

Drawn By:

JDF

Checked By:

Date:

11/12/07

Scale:

None

Acad Number:

HSS-1004 1005- elevation

Sheet

Of

Revision: 2

Drawing Number:

HSS-H1004/1005

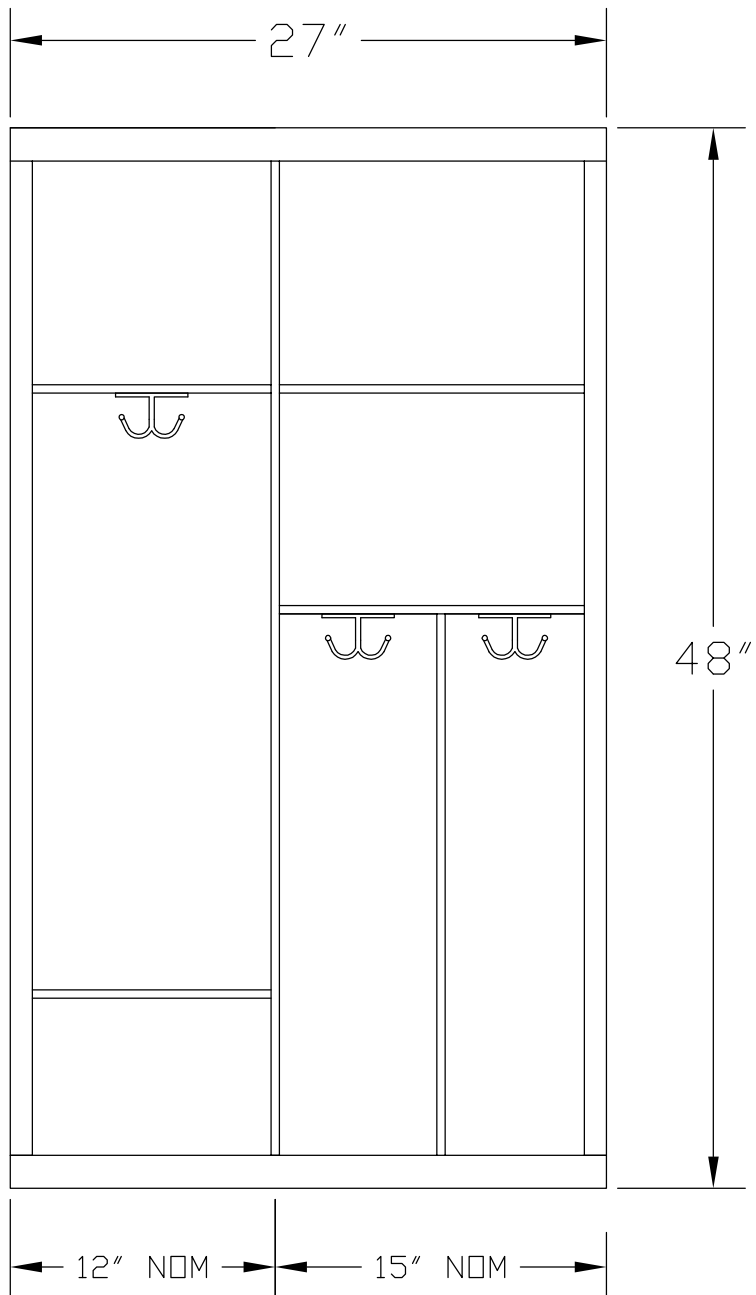

*PRIMARY II
CUBBIE*

*BACKPACK
CUBBIE*

<i>HALLOWELL SALES SAMPLE - WELDED CUBBIE</i>			
COMPONENT	GAUGE	MATERIAL	REMARKS
UNIT SIDES	16	COLD ROLLED STEEL	SOLID
BACK	18	COLD ROLLED STEEL	SOLID
BOTTOM	16	GALVANNEALED C.R.S.	SOLID
INTERMEDIATE SIDES	18	COLD ROLLED STEEL	SOLID - BEADED
BACKPACK CENTER PARTITION	18	COLD ROLLED STEEL	SOLID - BEADED
SHELVES	18	COLD ROLLED STEEL	SOLID - BEADED
TOP	16	COLD ROLLED STEEL	SOLID
FRAME	16	COLD ROLLED STEEL	UNI-BODY



Description:

CUBBIE LOCKER
SALES SAMPLE

Drawn By: JDF

Checked By:

Date: 8/04/03

Scale: None

Acad Number: HSS-CUB

Sheet Of

Revision:

Drawing Number:

HSS-CUB

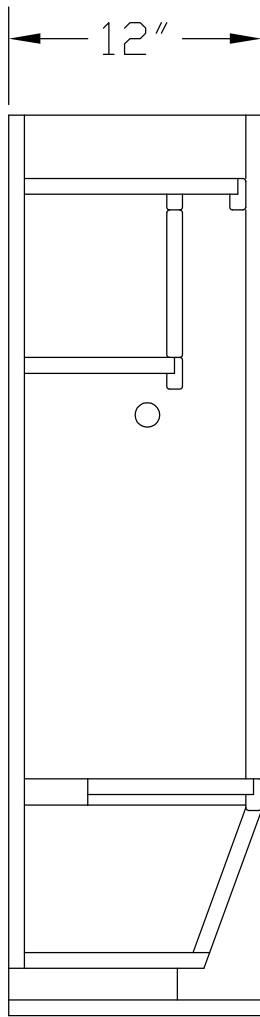

SIDE VIEW

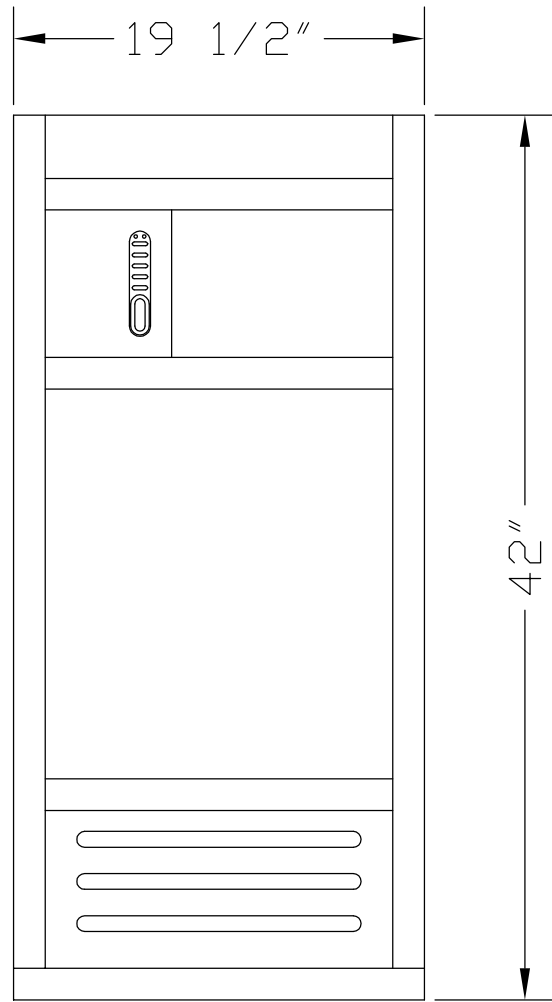

FRONT VIEW

AMP SALES SAMPLE - RECRUITER		
COMPONENT	MATERIAL	REMARKS
DOOR	RED OAK LUMBER	
HINGE	COLD ROLLED STEEL	CONTINUOUS TYPE - BRIGHT BRASS PLATED
HANDLE / LOCK		HALLOWELL - DIGITECH LOCK
SIDES	3/4" FURNITURE GRADE RED OAK PLYWOOD	
BACK	3/4" FURNITURE GRADE RED OAK PLYWOOD	
GRATES	3/4" FURNITURE GRADE RED OAK PLYWOOD	
SEAT	3/4" FURNITURE GRADE RED OAK PLYWOOD	
SHELVES	3/4" FURNITURE GRADE RED OAK PLYWOOD	
TRIM	RED OAK LUMBER	
VALANCES	RED OAK LUMBER	
COAT ROD	CHROME PLATED	1/2" DIAMETER

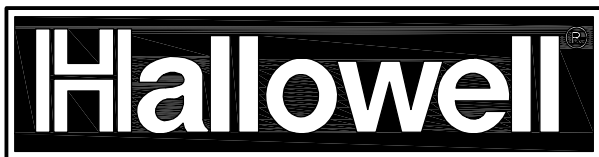

Description: RECRUITER SALES SAMPLE			
Drawn By: JFA	Checked By:	Date: 09/26/11	Scale: NONE
Acad Number: HSS-RECRUITER-ELEVATION		Sheet 0f	Revision: 1
Drawing Number: HSS-RECRUITER			

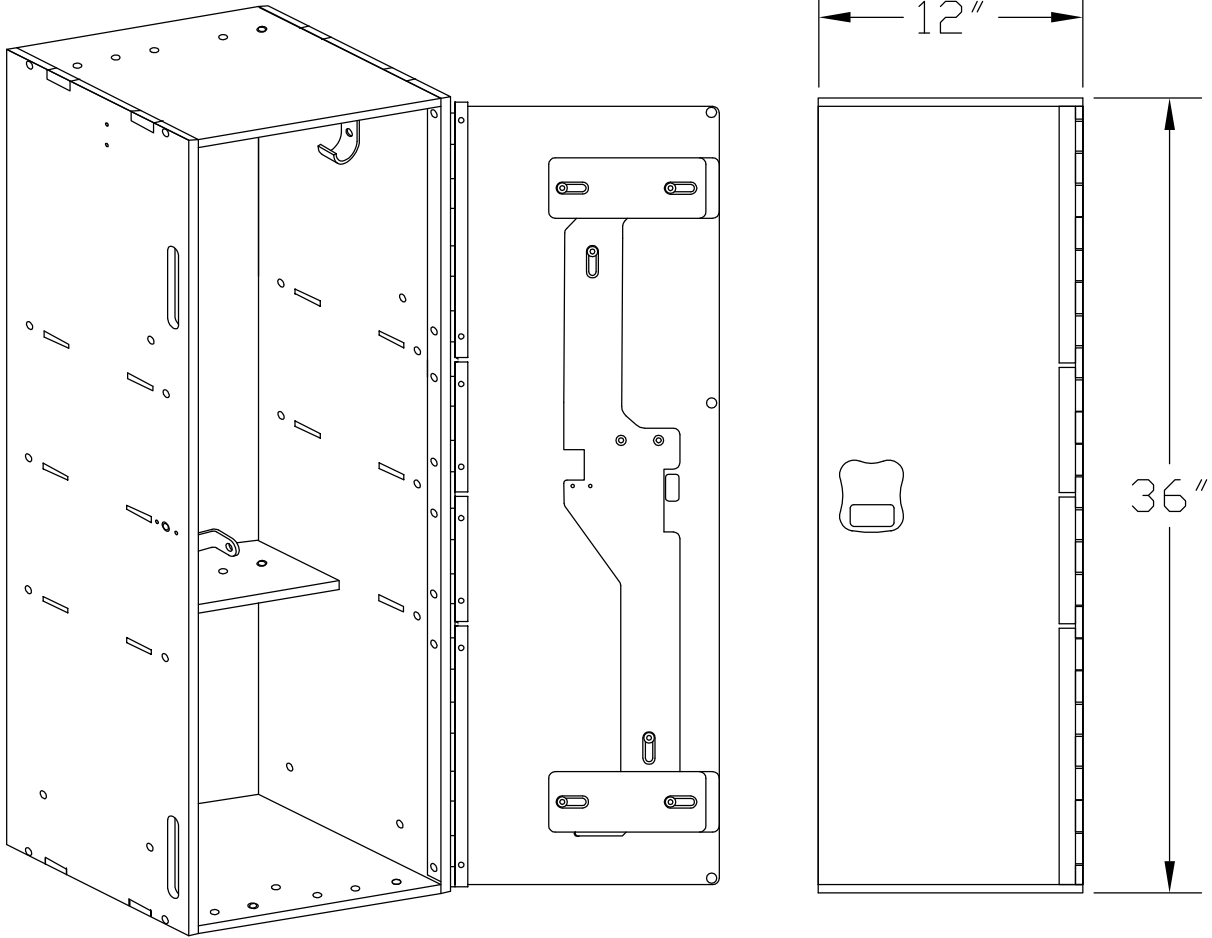

ISOMETRIC VIEW

FRONT VIEW

HALLOWELL SALES SAMPLE - AQUAMAX PLASTIC LOCKER

COMPONENT	THICKNESS	MATERIAL	REMARKS
DOOR	1/2"	HIGH-DENSITY POLYETHYLENE	SOLID
HINGE		ALUMINUM	SOLID
HANDLE		HIGH-DENSITY POLYETHYLENE	INJECTION MOLDED
SIDES	3/8"	HIGH-DENSITY POLYETHYLENE	SOLID
BACKS	3/8"	HIGH-DENSITY POLYETHYLENE	SOLID
TOP	3/8"	HIGH-DENSITY POLYETHYLENE	SOLID
BOTTOM	3/8"	HIGH-DENSITY POLYETHYLENE	SOLID



Description: AQUAMAX PLASTIC LOCKER
SALES SAMPLE

Drawn By: JFA	Checked By:	Date: 07/30/15	Scale: None
---------------	-------------	----------------	-------------

Acad Number: HSS-AQUA-elevation	Sheet Of	Revision:
---------------------------------	----------	-----------

Drawing Number: HSS-AQUAMAX